

# Roller Shutters



  
Everton™

Available at  
**BUNNINGS**  
warehouse

Take This Brochure to the Special Orders Desk to place an order





# Shutter systems explained

Our standard range is hand picked to include our most popular options and sizes, taking the guesswork out of your roller shutter selection.

## Sizes up to 7m<sup>2</sup>

- Max width 3m

## Foam Filled Aluminium Blades

- Powder coated for durability

## 3 Control System Options

All remote control operated:

### 1. Battery

- DIY install
- Works during a blackout

### 2. Solar

- Easiest DIY install
- Works during a blackout
- One hour of direct sunlight equals one week of normal operation

### 3. Hardwired

- Electrician required for installation
- Fully integrates into house circuitry for premium finish
- Smart home compatible

## Why buy a roller shutter?

### Privacy

Complete window block-out keeps out prying eyes and excess noise whilst deterring vandals and thieves.

### Climate control

Stops the sun from heating up your home in summer and keeps heat from escaping in winter.

### Energy Savings

Better control over your homes' climate means you need less energy to keep it comfortable, providing up to 40% energy savings.

### Light control

Put a dimmer on the sun. From full natural light to complete darkness, you are in control.

### Fire Protection

Our fire rated system helps protect your home against ember attack and radiant heat in the event of a fire.

### Cyclone Protection

Our cyclone rated system helps protect your windows and doors from debris and the extreme pressure changes of a storm.

POWDER COATING

**5**  
YEAR WARRANTY

MECHANICAL COMPONENTS AND MOTORS

**3**  
YEAR WARRANTY

CONTROL SYSTEMS

**1**  
YEAR WARRANTY

BATTERIES

**6**  
MONTHS WARRANTY

## ALL SYSTEMS ARE REMOTE CONTROLLED

Multi-channel remotes allow for easy grouping of shutters

One touch programming

Group shutters on channels

*Example:*

Channel 1 - all shutters

Channel 2 - front of house

Channel 3 - master bedroom



## DIY Installation

Roller shutters have a medium to high level of difficulty for installation. It's recommended for experienced DIY enthusiasts or trades people.

Hardwired systems need to be installed by a qualified electrician or roller shutter installer in your area.

For full installation instructions download the "Roller Shutter Tech Manual" downloadable on at [everton.com.au](http://everton.com.au)

# Completing the order form

### 1. Room Location

Choose a name or description for each roller shutter to plan your order. This description will appear as a sticker on the wrapping of your roller shutter when it arrives to help identify where it will be installed e.g. master bedroom, kitchen, bedroom 1, bedroom 2.

### 2. Install Type

There are 2 methods of installation. On-Wall or In-Reveal.

We recommend On-Wall - it's easier to fit for DIY and you don't lose any viewing area through the window.

You will only need to use in-reveal fitting if any of the following apply:

there is less than 300mm of clear space above the window to allow space for headbox; or there is less than 150mm of clear space on either side of the window to allow space for shutter guides.

### 3. Packing extrusion or bottom guides?

Packing extrusion is used when there is something blocking the path of the shutter, e.g. a door handle. The profile packs the shutter out from the wall to avoid any obstacles.

Bottom guides may be required if the opening has no sill. If either of these are required, simply write *packing req* or *bottom guide req* in the notes column.

In-reveal side view with sill

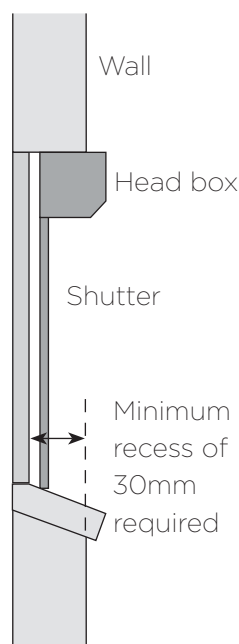

On-wall side view with sill

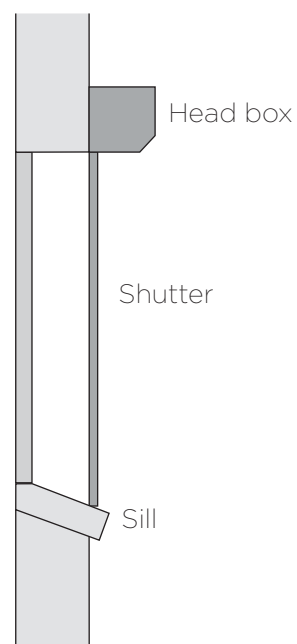

On-wall side view with no sill

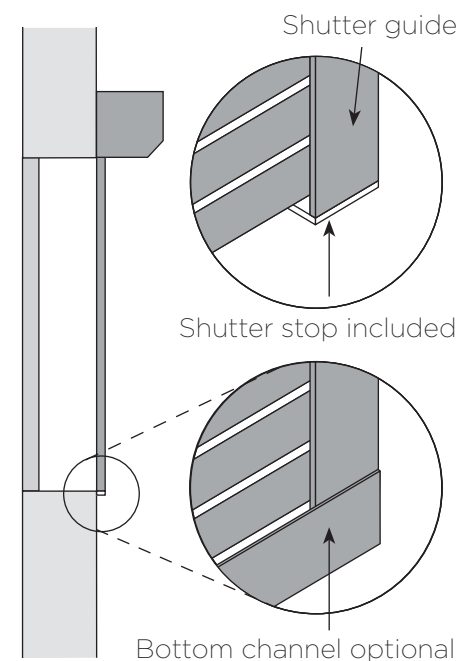

### 4. Height and Width

- Measure each side and the middle of the window opening to the outside of the frame.
- Include architrave for on-wall installation.
- Do not include architrave for in-reveal installation.

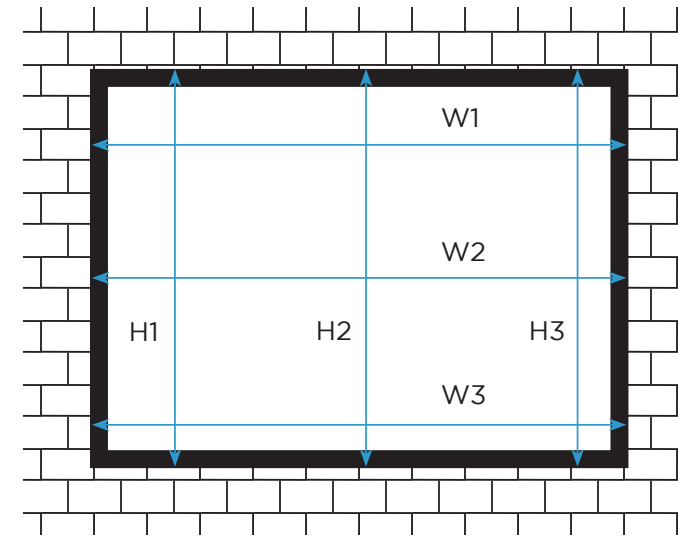

Window with architrave

Window with sill

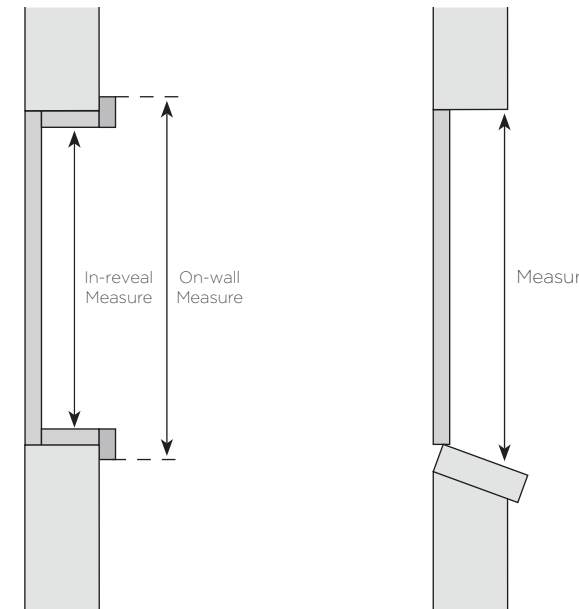

### 5. Control System

Select either a battery, solar or hardwired control system for this shutter. You only need one remote. You can purchase one for each room if desired. Manual control can also be selected as an option by leaving this section blank and writing *manual* in the notes section.

### 6. Control Side

Select if the control will appear on the left or right of the window when viewed from the inside.

### 7. Colour

Select the colour for your roller shutter.



Colours shown here have been reproduced to represent actual product colours as accurately as possible. If unsure, we recommend checking your chosen colour against an actual sample of the product before purchasing as varying light conditions and limitations of the printing process may affect colour tones.

### 8. Control System Remote Controllers

Indicate the number of remotes required for the different control systems. At least one remote is required, but you can get more.

If you are ordering a battery system, indicate the number of wall chargers you would like to purchase. At least one will be required to charge your battery system.

### 9. Assess your job

Will you require specialised shutters *i.e. fire or cyclone rated?*

Check with your local council about requirements in your area.

If required write it in the notes column *fire rated* or *cyclone rated* followed by the rating required e.g. *fire rated BAL 40* or *cyclone rated C3*.

### 10. Extras

Include any additional explanatory notes or special requirements e.g. -

- Fire or cyclone rating
- Packing extrusion
- Bottom guides
- Matching headbox sizes

Once you've filled out the form, return it to your local Bunnings' Special Orders Desk.

# Roller Shutters Order Form

BUNNINGS USE ONLY

Store Name: \_\_\_\_\_ Date: \_\_\_\_\_  
 Store Number: \_\_\_\_\_ Bunnings PO Number: \_\_\_\_\_  
 Store Contact: \_\_\_\_\_ Bunnings COS Number: \_\_\_\_\_  
 Store Tel: \_\_\_\_\_ Customer Sign-Off: \_\_\_\_\_



For more information on any of these options, refer to pages 4 & 5 of this brochure. No cancellations once signed order is submitted.  Quote  Order

Fineline	Room Location	Width (mm)			Height (mm)			Colour			Control System						
		W1	W2	W3	H1	H2	H3	White	Cream	Woodland Grey	Black	Battery	Hardwired	Control Side			
BUNNINGS USE ONLY	Example	1805	1805	1804	2204	2205	2204	✓	✓	✓		✓		R	See note <sup>1</sup> below	Extras <sup>1</sup>	QTY

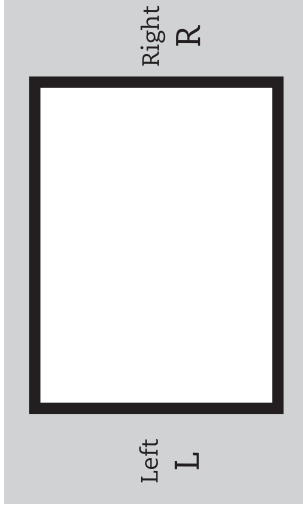
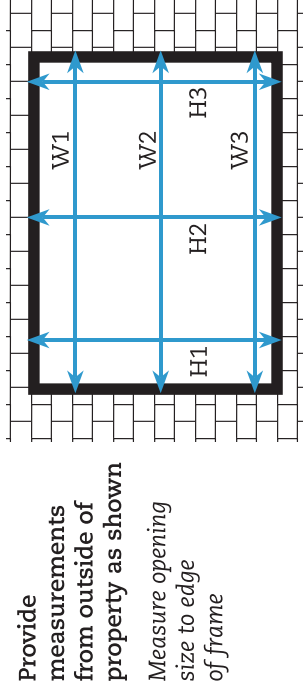

Control System Remote Controllers	QTY
Battery or Solar requires remote	
Hardwired requires remote	
Battery System requires an AC charger.	
Note: one remote can operate up to 20 shutters per system.	

<sup>1</sup> Indicate if any of the following are required:  
 fire of cyclone rating, bottom channel, packing  
 extrusion or matching headbox sizes.



2a Page St, Kunda Park, QLD, 4559 (07) 5476 5022

Submit by email to sales@protectorpremium.com.au

## Roller Shutter Fineline Table

Height	Width			1000-1200			1201-1400			1401-1600			1601-1800			1801-2000			
	BAT	SOL	HWD	BAT	SOL	HWD	BAT	SOL	HWD	BAT	SOL	HWD	BAT	SOL	HWD	BAT	SOL	HWD	
<1000	16595	165604	165589							16596	165605	165590							
	208385	208447	208322							208388	208448	208323							
1000-1200	IR			163979	164027	163929	208390	208449	208324	163979	164027	163929	208390	208449	208324	163979	164027	163929	208390
	OW			208390	208449	208324				208391	208451	208325				208393	208452	208326	208394
1201-1400	IR						163983	164032	163934	163984	164033	163936				163985	164034	163937	163986
	OW						208395	208456	208329	208396	208457	208330				208397	208459	208331	208398
1401-1600	IR			163991	164041	163942	208402	208465	208338	163993	164043	163945				163994	164044	163946	163994
	OW			208402	208465	208338				208405	208467	208340				208406	208469	208341	208406
1601-1800	IR									163998	164048	163951				163999	164049	163953	
	OW									208410	208474	208349				208412	208475	208351	
1801-2000	IR	165599	165606	165591						164001	164051	163956				164002	164052	163957	164003
	OW	208414	208477	208354						208415	208478	208355				208417	208479	208357	208418
2001-2200	IR	165601	165607	165592						164007	164058	163962				164008	164059	163963	164010
	OW	208424	208484	208362						208426	208487	208364				208427	208489	208365	208428
2201-2400	IR	165603	165608	165594												164017	164066	163971	164018
	OW	208436	208497	208374												208437	208498	208375	208439

Height	Width			2201-2400			2401-2600			2601-2800			2801-3000			3001-3200			
	BAT	SOL	HWD	BAT	SOL	HWD	BAT	SOL	HWD	BAT	SOL	HWD	BAT	SOL	HWD	BAT	SOL	HWD	
<1000	IR																		
	OW																		
1000-1200	IR																		
	OW																		
1201-1400	IR	163987	164037	163939	163988	164038	163940	163990	164040	163990	164040	163941							
	OW	208399	208461	208333	208400	208462	208334	208401	208463	208401	208463	208337							
1401-1600	IR	163995	164045	163947	163996	164046	163948	163997	164047	163997	164047	163949							
	OW	208407	208470	208342	208408	208472	208343	208409	208473	208409	208473	208346							
1601-1800	IR																		
	OW																		
1801-2000	IR	164004	164055	163959															
	OW	208422	208481	208359															
2001-2200	IR	164011	164061	163965	164012	164062	163966	164014	164063	163968	164015	164064	163969						
	OW	208430	208492	208367	208431	208493	208368	208432	208494	208371	208434	208495	208372						
2201-2400	IR	164021	164069	163973	164022	164072	163974	164023	164074	163975	164024	164076	163976						
	OW	208440	208501	208377	208441	208502	208379	208443	208503	208380	208444	208504	208381						

### Accessories

Item no.	Description	Item no.	Description
164079	4 CHANNEL REMOTE - (HARDWIRED SYSTEM)	165610	PACKING EXTRUSION - POWDERCOATED PER METRE
164080	9 CHANNEL REMOTE - (BATTERY & SOLAR SYSTEMS)	165609	BOTTOM RAIL - POWDERCOATED PER METRE
		164082	AC CHARGER - (BATTERY SYSTEM)

# How It works

---

It's as simple as 1,2,3! Follow the steps shown to purchase or order your product. If you need further advice, speak to a Team member at the Special Orders Desk in-store.

---

## 1. Select The Product You Want

View the extensive range available in this brochure or online to select the item that best suits your needs.

---

## 2. Order At The Special Orders Desk

After you have selected the product you want, take this brochure to the Special Orders Desk.

---

## 3. Get It Home

### We Will Deliver

Delivery to your home or site can be arranged in-store when purchasing your products.

### Pick-Up In-Store

If you decide to pick-up in-store and need help to get it home, you can:

- borrow a courtesy trailer
- hire a vehicle

Check with your local Bunnings store for availability.

---

