

ozito

MULTI PURPOSE MIXER

1050W

INSTRUCTION MANUAL

SPECIFICATIONS

Motor:	1050W
Input:	230-240V ~ 50Hz
No Load Speed:	0-550/min
Max. Mixing Capacity:	80L
Mixing Paddle Length:	590mm
Mixing Paddle Diameter:	125mm
Mixing Paddle Thread:	M14 x 2.0mm
Weight:	3.05kg

ozito.com.au

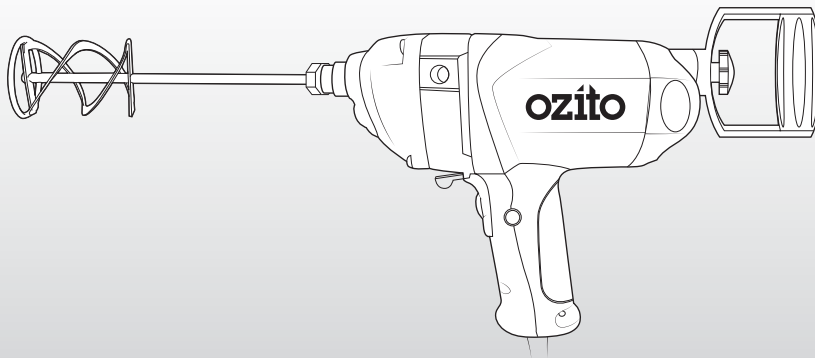

STANDARD EQUIPMENT

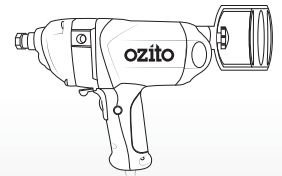

Multi-Purpose Mixer

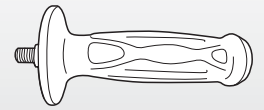

Side Handle



Mixing Paddle

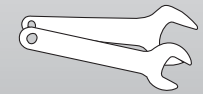

2 x Spanner

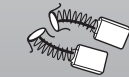

Spare Brushes (Pair)

3 YEAR REPLACEMENT WARRANTY

DMM-080

WARRANTY

IN ORDER TO MAKE A CLAIM UNDER THIS WARRANTY YOU MUST RETURN THE PRODUCT TO YOUR NEAREST BUNNINGS WAREHOUSE WITH YOUR BUNNINGS REGISTER RECEIPT. PRIOR TO RETURNING YOUR PRODUCT FOR WARRANTY PLEASE TELEPHONE OUR CUSTOMER SERVICE HELPLINE:

Australia 1800 069 486

New Zealand 0508 069 486

TO ENSURE A SPEEDY RESPONSE PLEASE HAVE THE MODEL NUMBER AND DATE OF PURCHASE AVAILABLE. A CUSTOMER SERVICE REPRESENTATIVE WILL TAKE YOUR CALL AND ANSWER ANY QUESTIONS YOU MAY HAVE RELATING TO THE WARRANTY POLICY OR PROCEDURE.

The benefits provided under this warranty are in addition to other rights and remedies which are available to you at law.

Our goods come with guarantees that cannot be excluded at law. You are entitled to a replacement or refund for a major failure and for compensation for any other reasonably foreseeable loss or damage. You are also entitled to have the goods repaired or replaced if the goods fail to be of acceptable quality and the failure does not amount to a major failure.

Generally you will be responsible for all costs associated with a claim under this warranty, however, where you have suffered any additional direct loss as a result of a defective product you may be able to claim such expenses by contacting our customer service helpline above.

3 YEAR REPLACEMENT WARRANTY

Your product is guaranteed for a period of **36 months from the original date of purchase** and is intended for DIY (Do It Yourself) use only. If a product is defective it will be replaced in accordance with the terms of this warranty. Warranty excludes consumable parts, for example: carbon brushes, mixing paddle, spanners, side handle, etc.

WARNING

The following actions will result in the warranty being void.

- If the tool has been operated on a supply voltage other than that specified on the tool.
- If the tool shows signs of damage or defects caused by or resulting from abuse, accidents or alterations.
- Failure to perform maintenance as set out within the instruction manual.
- If the tool is disassembled or tampered with in any way.

KNOW YOUR PRODUCT

MULTI-PURPOSE MIXER

- | | |
|------------------------|---------------------------|
| 1 Collet | 6 Forward / Reverse Lever |
| 2 Side Handle | 7 Variable Speed Dial |
| 3 Mixer Housing | 8 On/Off Trigger |
| 4 Handle Securing Knob | 9 Lock-Off Button |
| 5 Rear Spade Handle | 10 Mid Handle |

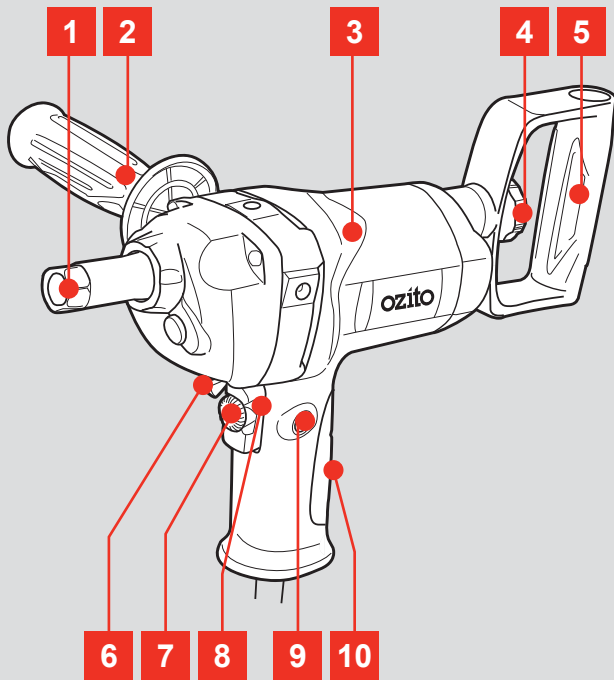

ACCESSORIES

- | | |
|------------------|-------------------------|
| 11 Mixing Paddle | 13 Spanner 22mm |
| 12 Spanner 19mm | 14 Spare Brushes (Pair) |

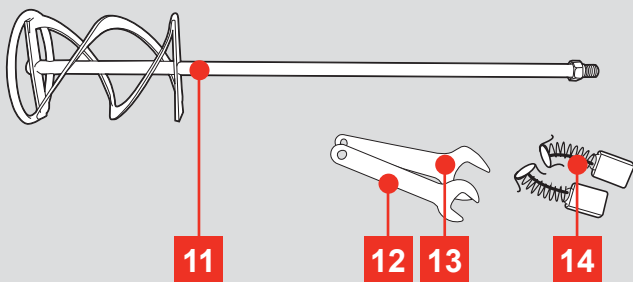

ONLINE MANUAL

Scan this QR Code with your mobile device to take you to the online manual.



SETUP & PREPARATION

1. HANDLES



WARNING! ENSURE THE TOOL IS SWITCHED OFF AND DISCONNECTED FROM THE POWER SUPPLY BEFORE PERFORMING ANY OF THE FOLLOWING ASSEMBLY.

Side Handle

The side handle provides additional comfort, control, and guidance for the mixer. The handle can be fitted in 3 positions to suit the user.

- 1 Align the side handle with 1 of the 3 hole position in the mixer housing.

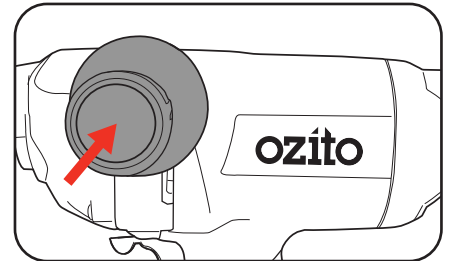

- 2 Rotate the handle in a clockwise direction to secure in place.

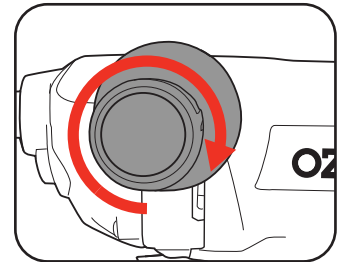

Spade Handle

The rear spade handle provides additional control and support when using the tool. It can be attached either horizontally, vertically or should you require it, diagonally.

- 1 Place the spade handle into the locating boss at the angle you desire.

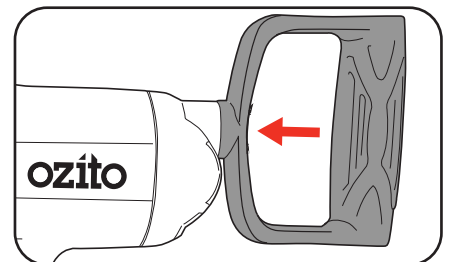

- 2 Screw the securing knob clockwise into the recess to secure in place.

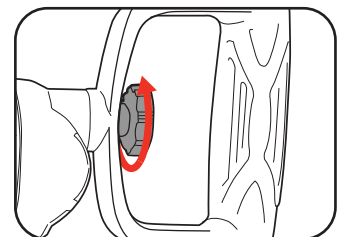

- 3 To change the angle, loosen the securing knob. Adjust the handle angle and retighten the securing knob.

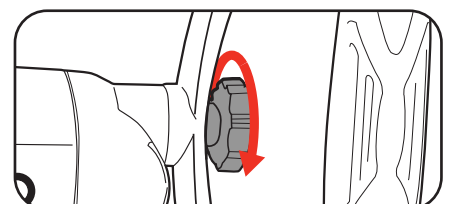

3 YEAR REPLACEMENT WARRANTY

OPERATION

2. FITTING & REMOVING THE PADDLE

- 1 Align the mixing paddle with the collet at the front of the mixer.

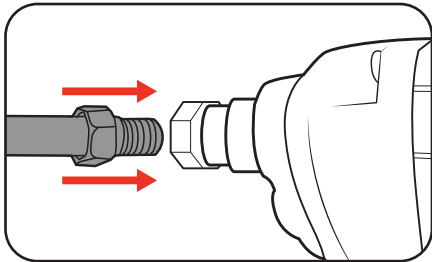

- 2 Screw the mixing paddle clockwise into the collet nut.

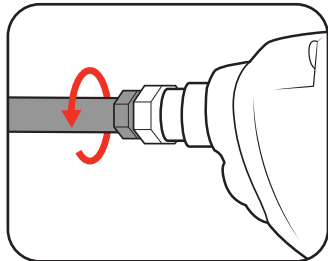

- 3 Using the supplied spanners, hold the collet nut in place whilst tightening the nut on the mixing paddle in a clockwise direction.

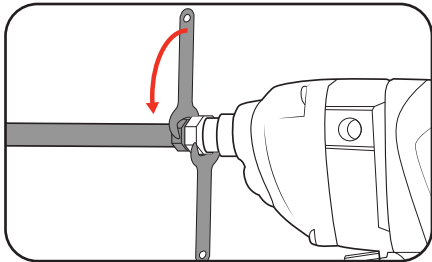

Note: Ensure the mixing paddle is tightly secured in place before operating.

- 4 To remove the mixing paddle, loosen the nut on the mixing paddle using both of the supplied spanners.

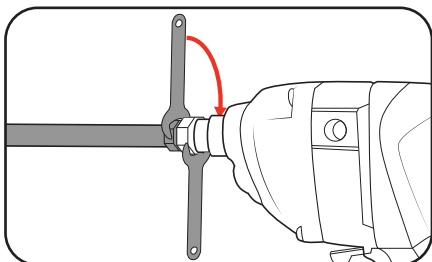

3. ON/OFF SWITCH



WARNING! TO REDUCE THE RISK OF ELECTRICAL SHOCK, THE USE OF A RESIDUAL CURRENT DEVICE (RATED 30mA OR LESS) IS RECOMMENDED.

On/Off Trigger

The tool has a variable speed trigger, the further you depress the on/off trigger the higher the speed of the mixer.

- 1 To start the mixer, press and hold the lock-off button, then squeeze the on/off trigger.

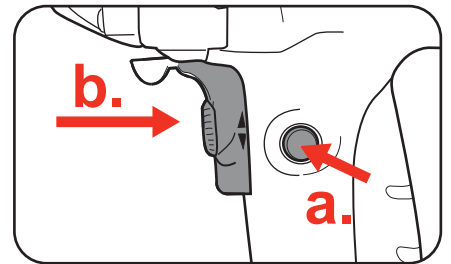

Note: Once the tool has started you can release the lock-off trigger.

- 2 To stop the mixer, release the on/off trigger.

3. CONTROLS

Variable Speed Dial

The on/off trigger has a variable speed dial that limits the maximum speed of the mixer.

- 1 To increase the maximum speed, rotate the variable speed dial clockwise.

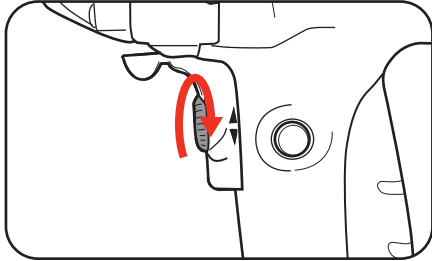

- 2 To decrease the maximum speed, rotate the variable speed dial anti-clockwise.

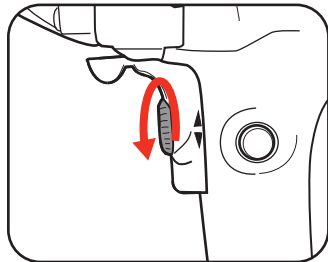

Forward/Reverse Lever

- 1 To mix in a forward direction, push the forward/reverse lever towards the left side of the mixer.

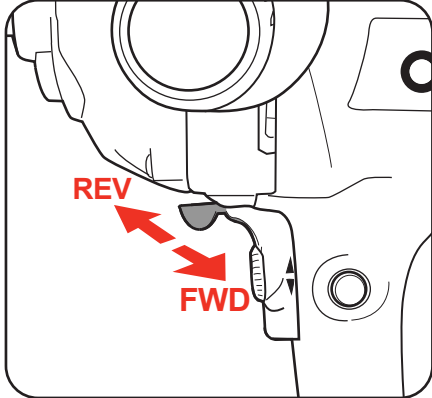

- 2 To mix in a reverse direction, push the forward/reverse lever towards the right side of the mixer.

4. MIXING

Before starting to operate the mixer, perform a few simple checks.

- 1 Check the forward/reverse lever is on desired setting.
- 2 Place the mixing paddle into the material to be mixed.

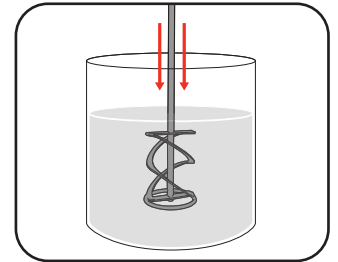
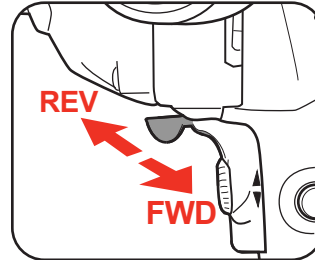

- 3 Hold the mixer firmly and squeeze the on/off trigger.

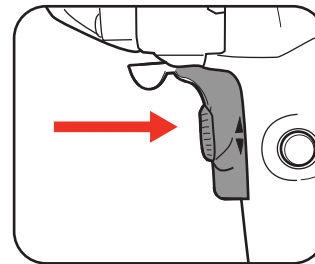

- 4 Move the mixing paddle through the material slowly to mix evenly.

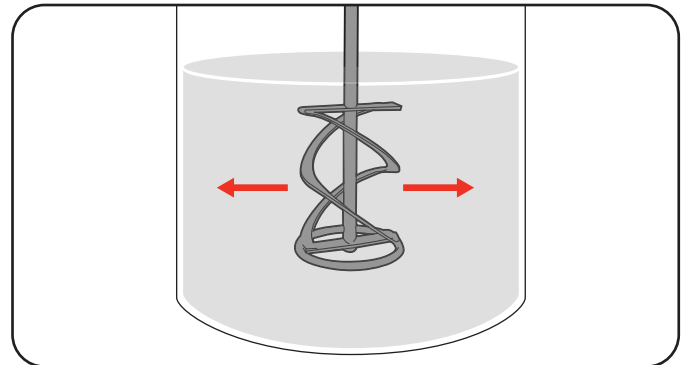

Note: Do not force the mixer or apply additional pressure. Let the mixer do all the work.



WARNING! ALWAYS REDUCE THE SPEED WHEN SUBMERGING THE MIXER IN THE MATERIAL OR LIFTING IT OUT. ONCE THE MIXER IS FULLY SUBMERGED, INCREASE THE SPEED AGAIN TO ENSURE THAT THE MOTOR IS ADEQUATELY COOLED.

MAINTENANCE

- Keep the vents on the mixer clean at all times, if possible, prevent foreign matter from entering the vents.
- After each use, blow air through the mixer housing to ensure it is free from all dust particles which may build up. Build up of dust particles may cause the mixer to overheat and fail.
- If the enclosure of the mixer requires cleaning, do not use solvents. Use a moist, soft cloth only. Never let any liquid get inside the mixer; never immerse any part of the mixer into a liquid.
- If the supply cord is damaged, it must be replaced by the manufacturer, its service agent or similarly qualified persons in order to avoid a hazard.



Carbon Brushes

When the carbon brushes wear out, the mixer will spark and/or stop. Discontinue use as soon as this happens. Carbon brushes should be replaced prior to recommencing use of the mixer. They are a wearing component of the mixer and therefore not covered under warranty. Continuing to use the mixer

when carbon brushes need to be replaced may cause permanent damage to the mixer. Carbon brushes will wear out after many uses. When the carbon brushes need to be replaced, take the mixer to an electrician or a power tool repairer for a quick and low cost replacement. Always replace both carbon brushes at the same time.

Note: Ozito Industries will not be responsible for any damage or injuries caused by the repair of the mixer by an unauthorised person or by mishandling of the mixer.

TROUBLESHOOTING

Sparking visible through the housing air vents

A small amount of sparking may be visible through the housing vents. This is normal and does not indicate a problem.

Excessive sparking visible through the housing air vents and/or the mixer failing to operate



May indicate the carbon brushes have worn out and need to be replaced. Carbon brushes should only be replaced by a qualified electrician or power tool repairer.

Trigger is locked and cannot be pressed

The forward/reverse lever may be positioned in the middle. Push the forward/reverse lever towards the left or right depending on the desired direction of rotation.

DESCRIPTION OF SYMBOLS

V	Volts	Hz	Hertz
~	Alternating Current	W	Watts
/min	Revolutions or reciprocations per minute	n₀	No load speed
	Wear eye, ear & breathing protection	∅	Diameter
	Regulatory Compliance Mark (RCM)		Warning
	Read Instruction Manual		Double Insulation

SPARE PARTS

Spare parts can be ordered from the Special Orders Desk at your local Bunnings Warehouse.

For further information, or any parts not listed here, visit www.ozito.com.au or contact Ozito Customer Service:

Australia 1800 069 486

New Zealand 0508 069 486

E-mail: enquiries@ozito.com.au

CARING FOR THE ENVIRONMENT



Power tools that are no longer usable should not be disposed of with household waste but in an environmentally friendly way. Please recycle where facilities exist. Check with your local council authority for recycling advice.



Recycling packaging reduces the need for landfill and raw materials. Reuse of recycled material decreases pollution in the environment. Please recycle packaging where facilities exist. Check with your local council authority for recycling advice.



ELECTRICAL SAFETY



WARNING! When using mains-powered tools, basic safety precautions, including the following, should always be followed to reduce risk of fire, electric shock, personal injury and material damage.

Read the whole manual carefully and make sure you know how to switch the tool off in an emergency, before operating the tool.

Save these instructions and other documents supplied with this tool for future reference.

The electric motor has been designed for 230V and 240V only. Always check that the power supply corresponds to the voltage on the rating plate.

Note: The supply of 230V and 240V on Ozito tools are interchangeable for Australia and New Zealand.



This tool is double insulated therefore no earth wire is required.

Note: Double insulation does not take the place of normal safety precautions when operating this tool. The insulation system is for added protection against injury resulting from a possible electrical insulation failure within the tool.

This tool is recommended for the use with a residual current device with a rated residual current of 30mA or less. If the supply cord is damaged, it must be replaced by the manufacturer, its service agent or similarly qualified persons in order to avoid a hazard.

Using an Extension Lead

Always use an approved extension lead suitable for the power input of this tool. Before use, inspect the extension lead for signs of damage, wear and ageing. Replace the extension lead if damaged or defective. When using an extension lead on a reel, always unwind the lead completely. Use of an extension lead not suitable for the power input of the tool or which is damaged or defective may result in a risk of fire and electric shock.



GENERAL POWER TOOL SAFETY WARNINGS



WARNING! Read all safety warnings and all instructions. Failure to follow the warnings and instructions may result in electric shock, fire and/or serious injury.

Save all warnings and instructions for future reference. The term "power tool" in the warnings refers to your mains-operated (corded) power tool or battery-operated (cordless) power tool.

1. Work area safety

- Keep work area clean and well lit. Cluttered or dark areas invite accidents.
- Do not operate power tools in explosive atmospheres, such as in the presence of flammable liquids, gases or dust. Power tools create sparks which may ignite the dust or fumes.
- Keep children and bystanders away while operating a power tool. Distractions can cause you to lose control.

2. Electrical safety

- Power tool plugs must match the outlet. Never modify the plug in any way. Do not use any adapter plugs with earthed (grounded) power tools. Unmodified plugs and matching outlets will reduce risk of electric shock.
- Avoid body contact with earthed or grounded surfaces, such as pipes, radiators, ranges and refrigerators. There is an increased risk of electric shock if your body is earthed or grounded.
- Do not expose power tools to rain or wet conditions. Water entering a power tool will increase the risk of electric shock.
- Do not abuse the cord. Never use the cord for carrying, pulling or unplugging the power tool. Keep cord away from heat, oil, sharp edges or moving parts. Damaged or entangled cords increase the risk of electric shock.
- When operating a power tool outdoors, use an extension cord suitable for outdoor use. Use of a cord suitable for outdoor use reduces the risk of electric shock.
- If operating a power tool in a damp location is unavoidable, use a residual current device (RCD) protected supply. Use of an RCD reduces the risk of electric shock.

3. Personal safety

- Stay alert, watch what you are doing and use common sense when operating a power tool. Do not use a power tool while you are tired or under the influence of drugs, alcohol or medication. A moment of inattention while operating power tools may result in serious personal injury.
- Use personal protective equipment. Always wear eye protection. Protective equipment such as dust mask, non-skid safety shoes, hard hat, or hearing protection used for appropriate conditions will reduce personal injuries.

- Prevent unintentional starting. Ensure the switch is in the off-position before connecting to power source and/or battery pack, picking up or carrying the tool. Carrying power tools with your finger on the switch or energising power tools that have the switch on invites accidents.
 - Remove any adjusting key or wrench before turning the power tool on. A wrench or a key left attached to a rotating part of the power tool may result in personal injury.
 - Do not overreach. Keep proper footing and balance at all times. This enables better control of the power tool in unexpected situations.
 - Dress properly. Do not wear loose clothing or jewellery. Keep your hair, clothing and gloves away from moving parts. Loose clothes, jewellery or long hair can be caught in moving parts.
 - If devices are provided for the connection of dust extraction and collection facilities, ensure these are connected and properly used. Use of dust collection can reduce dust-related hazards.
- ## 4. Power tool use and care
- Do not force the power tool. Use the correct power tool for your application. The correct power tool will do the job better and safer at the rate for which it was designed.
 - Do not use the power tool if the switch does not turn it on and off. Any power tool that cannot be controlled with the switch is dangerous and must be repaired.
 - Disconnect the plug from the power source and/or the battery pack from the power tool before making any adjustments, changing accessories, or storing power tools. Such preventive safety measures reduce the risk of starting the power tool accidentally.
 - Store idle power tools out of the reach of children and do not allow persons unfamiliar with the power tool or these instructions to operate the power tool. Power tools are dangerous in the hands of untrained users.
 - Maintain power tools. Check for misalignment or binding of moving parts, breakage of parts and any other condition that may affect the power tool's operation. If damaged, have the power tool repaired before use. Many accidents are caused by poorly maintained power tools.
 - Keep cutting tools sharp and clean. Properly maintained cutting tools with sharp cutting edges are less likely to bind and are easier to control.
 - Use the power tool, accessories and tool bits etc. in accordance with these instructions, taking into account the working conditions and the work to be performed. Use of the power tool for operations different from those intended could result in a hazardous situation.
- ## 5. Service
- Have your power tool serviced by a qualified repair person using only identical replacement parts. This will ensure that the safety of the power tool is maintained.



MULTI-PURPOSE MIXER SAFETY WARNINGS



WARNING! This appliance is not intended for use by young or infirm persons unless supervised by a responsible person to ensure that they can use the appliance safely. Young children should be supervised to ensure they do not play with the appliance.

- Always wear eye protection and a dust mask for dusty applications and when drilling/chiselling overhead. Sanding particles can be absorbed by your eyes and inhaled easily and may cause health complications.
- Use auxiliary handle(s), if supplied with the tool. Loss of control can cause personal injury.
- Hold power tool by insulated gripping surfaces, when performing an operation where the cutting accessory may contact hidden wiring or its own cord. Cutting accessory contacting a "live" wire may make exposed metal parts of the power tool "live" and could give the operator an electric shock.
- Recommendations for the use of a residual current device with a rated residual current of 30mA or less.
- Always use the side handle, this gives you greater control of the accessory should it become jammed.
- Keep the cord clear of the accessory being used, do not wrap the cord around your arm or wrist.
- Hold the tool by the insulated gripping surfaces when performing an operation where the accessory may contact hidden wiring or its own cord.
- When removing an accessory from the tool avoid contact with skin and use proper protective gloves when grasping the bit or accessory. Accessories may be hot after prolonged use.
- Young children should be supervised to ensure that they do not play with the appliance.
- Do not touch rotating parts.
- Do not manipulate the tool.
- Do not use the cable to carry the tool.
- Hold the tool with both hands at the intended handles. Loss of control can cause personal injury.
- Ensure sufficient ventilation when mixing flammable materials to avoid a hazardous atmosphere. Developing vapour may be inhaled or be ignited by the sparks the power tool produces.
- Do not mix food. Power tools and their accessories are not designed for processing food.
- Keep the cord away from the working area. The cord may be entangled by the

mixer basket.

- Ensure the mixing container is placed in a firm and secure position. A container that is not properly secured may move unexpectedly.
- Ensure that no liquid splashes against the housing of the power tool. Liquid that has penetrated the power tool can cause damage and lead to electric shock.
- Follow the instructions and warnings for the material to be mixed. Material to be mixed may be harmful.
- If the power tool falls into the material to be mixed, unplug the tool immediately and have the power tool checked by a qualified repair person. Reaching into the bucket with the tool still plugged in can lead to electric shock.
- Do not reach into the mixing container with your hands or insert any other objects into it while mixing. Contact with the mixer may lead to serious personal injury.
- Start up and run down the tool in the mixing container only. The mixer basket may bend or spin in an uncontrolled manner.
- Consider that there will be a reactionary torsional momentum.
- When working with dust, you must wear respiratory protection. Inhaling the dust may damage the respiratory tract.
- Always reduce the speed when submerging the mixer in the material or lifting it out. Once the mixer is fully submerged, increase the speed again to ensure that the motor is adequately cooled.



WARNING! Some dust created by power sanding, sawing, grinding, drilling and other construction activities contain chemicals known to cause cancer, birth defects or other reproductive harm.

Some examples of these chemicals are:

- Lead from lead-based paints;
- Crystalline silica from bricks, cement and other masonry products, and;
- Arsenic and chromium from chemically-treated timber.

The risk from such exposures vary depending on how often you do this type of work. To reduce your exposure to these chemicals; work in a well ventilated area, and work with approved safety equipment, such as those dust masks that are specifically designed to filter out microscopic particles.