

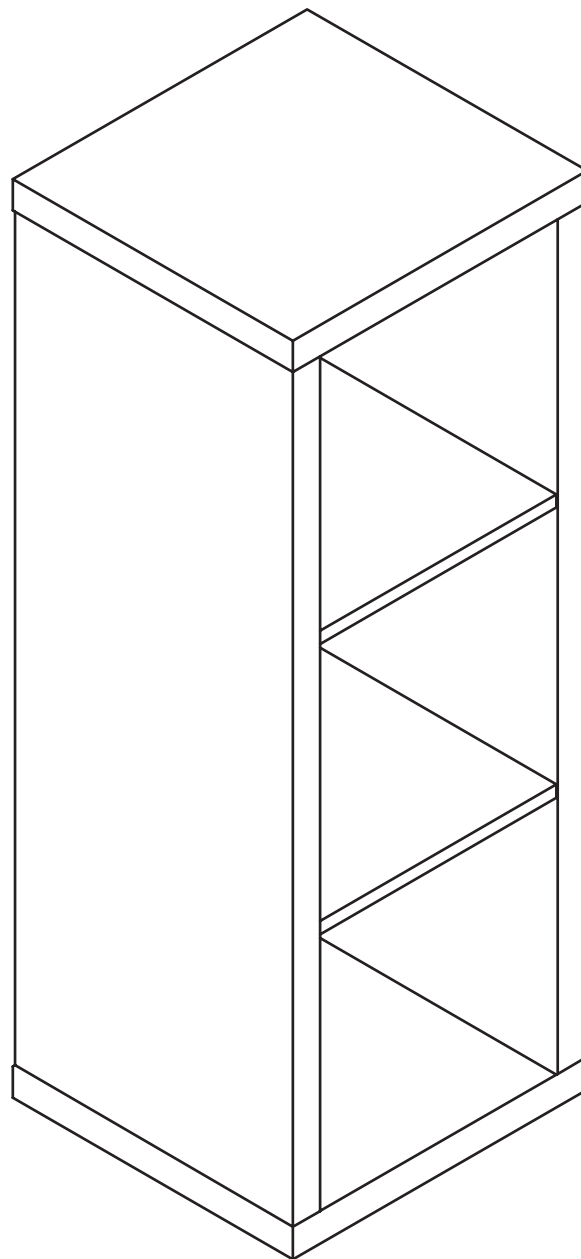

**THIS PRODUCT SHOULD BE ANCHORED TO A WALL OR OTHER SUITABLE SURFACE TO AVOID SERIOUS INJURY OR DEATH.**

To help avoid any serious injury or death, this product includes a bracket to prevent toppling. We strongly recommend that this product be permanently fixed to the wall or other suitable surface. Fixing hardware is not included since different surface materials require different attachments. Please seek professional advice if you are in doubt as to which fixing hardware to use. Regularly check your fixing device.



**Care Instructions:** We recommend to wipe over with a dry micro-fibre cloth to remove any dust. Avoid using a damp or wet cloth and any cleaning chemicals as this may cause damage to the surface.

**1 x 3 STORAGE UNIT ASSEMBLY INSTRUCTIONS**

**ELEMENT**

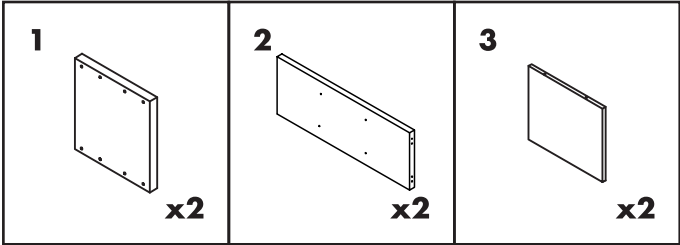

**HARDWARE**

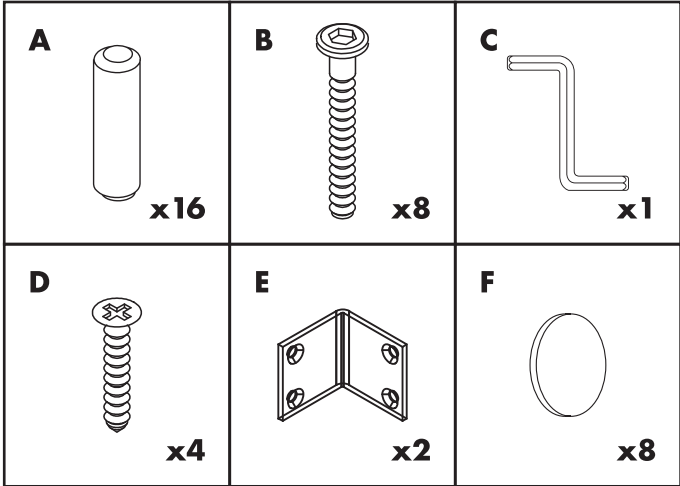

**STEP 1**

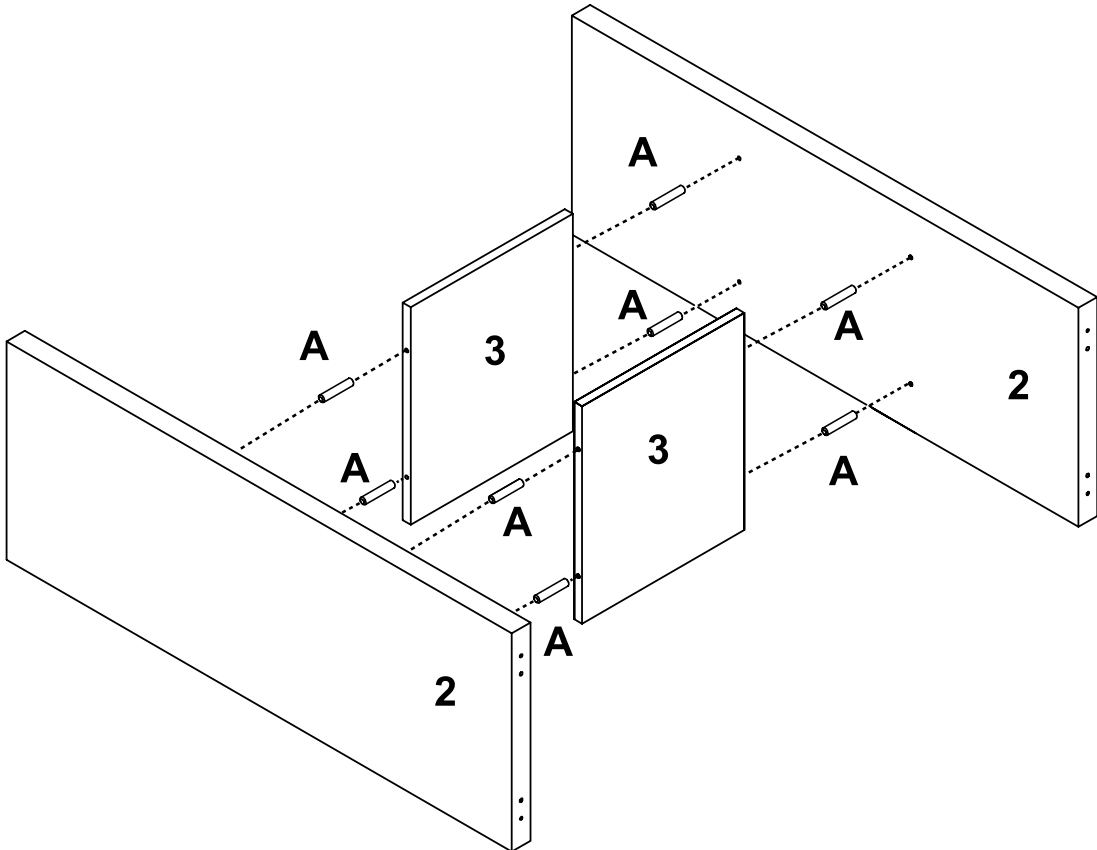

**STEP 2**

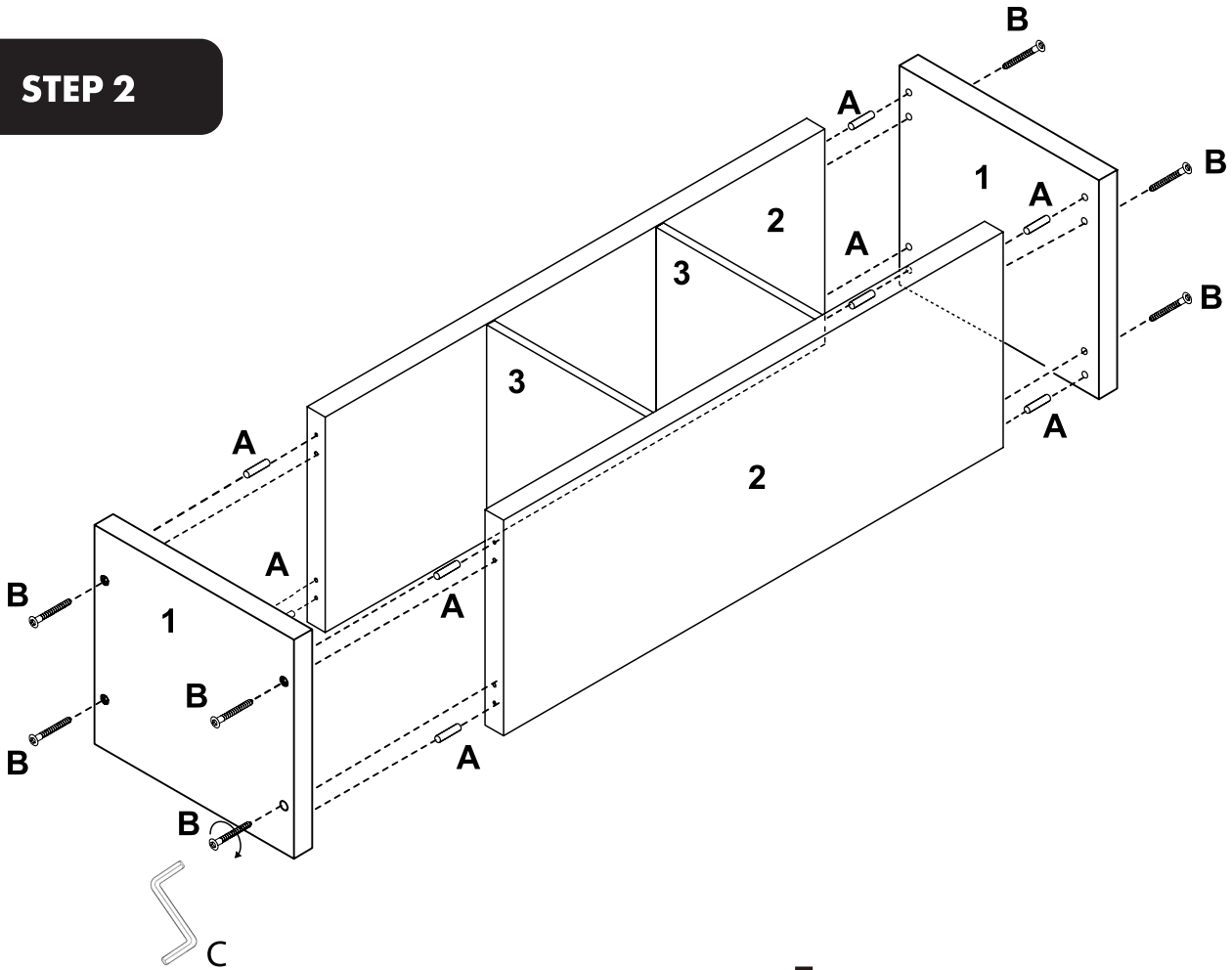

**STEP 3**

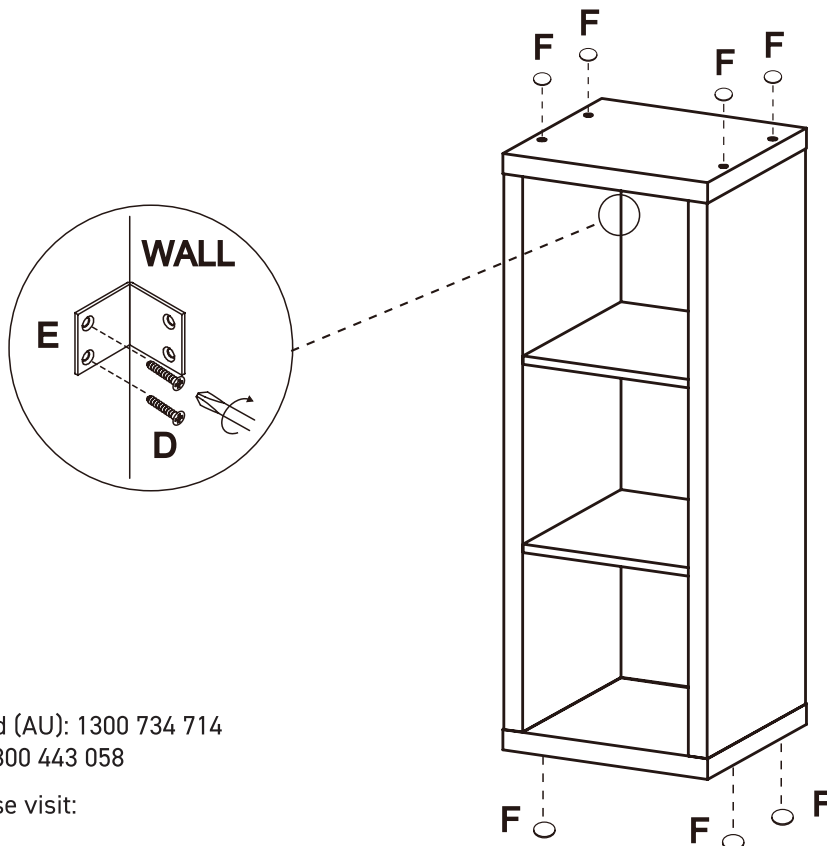

DISTRIBUTED BY:  
Visy Retail Services Pty Ltd (AU): 1300 734 714  
Visy Board Limited (NZ): 0800 443 058

For more information please visit:  
[flexistorage.com.au](http://flexistorage.com.au)  
[flexistorage.co.nz](http://flexistorage.co.nz)